

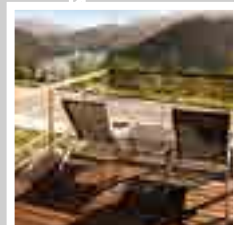

SIPHONS ABLÄUFE

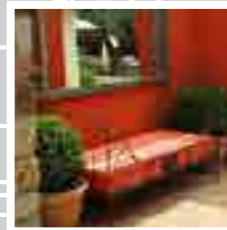

Ø 300



HL Продукти





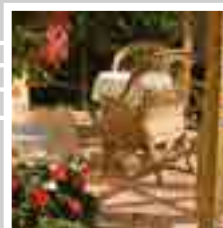

14. Гарнитури за
хидроизолации/Удължители

14

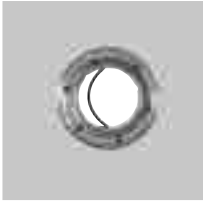
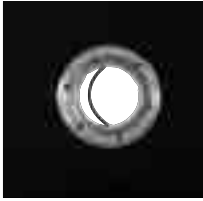
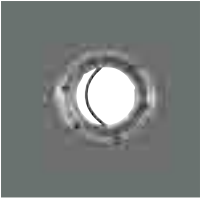

HL Гарнитурни за хидроизолации - Продукти - Преглед











Повече подробности за темата Хидроизолации също ще намерите в главите: подови сифони, безпрагови душ-кабини, балкони и тераси, хидроизолации на сгради

За моделите сифони	Тип на хидроизолационните материали		
	За алтернативни, респ. свързващи хидроизолации като например 2-компонентни епоксидни смоли или 2-компонентни флекс изолации	За EPDM мембрани, битумни грундове и за залепване с битумни мембрани, съвместими с битуми	За заваряване с битумни мембрани
	HL83.M	HL83	HL83.H *
HL83.M = HL70, HL80, HL90, HL92, HL300, HL304, HL310N, HL510N Удължителен елемент: HL85N			
	HL8300.M	HL8300	HL8300.H *
HL3100(T) und HL5100(T) Удължителен елемент: HL8500			
	HL84.M	HL84	**
HL72.1 und HL317 Удължителен елемент: HL350.1			
	HL86.M	HL86	HL86.H
HL615 und HL616 Удължителен елемент: HL618			
	—	—	HL84.H
Моделите воронки HL62, HL63, HL64 und HL69 Удължителен елемент: HL65			

* също се предлагат и със заводски монтиран битумен маншет за сериите сифони HL80, HL615, HL616, както и за сериите воронки HL62, HL64, HL63, HL69 и за удължителните елементи HL85, HL618, HL65.

















** получава се готова, монтирана със сифона!

*** гарнитурата за хидроизолацията (без маншета) може да се свърже към хидроизолационната мембрана, доставена от клиента

PVC-мембрани	FPO-мембрани	За притискане на еластични хидроизолационни мембрани, доставени от клиента	Хидроизолационни медни ламарини за покрив	Поцинковани ламарини за покрив
HL83.P	HL83.PP	HL83.0	–	–
				
HL8300.P	HL8300.PP	HL8300.0	–	–
				
***	***	HL84.0	–	–
				
***	***	HL86.0	–	–
				
**	**	**	HL84.CU	HL84.E
				







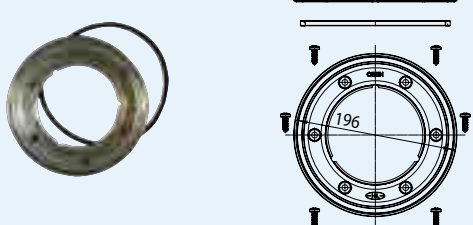

HL Удължителни елементи – Продукти – Преглед

Сифони за балкони и тераси	За настройка по височина на сифона към нивото на една алтернативна, респ. свързваща хидроизолация (епоксидна, хидроизолационно лепило)	За настройка по височина на фланеца за хидроизолацията до ниво хидроизолация	За настройка височината на подовия сифон до нивото на битумната мембрана
	HL85NC oder HL85N + HL83.M	HL85N	HL85NH
HL70, HL80, HL90, HL300, HL304, HL310N, HL510N			
	HL8500 + HL8300.M	HL8500	HL8500H
HL3100 и HL5100			
	HL360 oder HL370 oder HL350.0	HL350.0	HL350.1H
HL72.1 и HL317			
	HL618 + HL86.M	HL618	HL618H
HL615 и HL616			
	–	HL65	HL65H
Модели воронки HL62 и HL64			
	–	–	–
Сифони за балкони и тераси HL92			

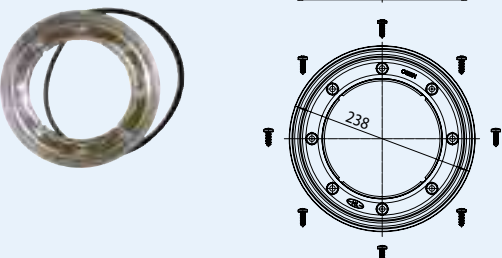
За настройка височината на сифона до нивото на PVC хидроизолацията	За настройка височината на сифона до нивото на FPO хидроизолацията	За удължаване на наставката
<p>HL85N + HL83.P</p>	<p>HL85N + HL83.PP</p>	<p>HL340N</p>
		
<p>HL8500 + HL8300.P</p>	<p>HL8500 + HL8300.PP</p>	<p>HL3400</p>
		
<p>HL350.0</p>	<p>HL350.0</p>	<p>HL350</p>
		
<p>HL618 + HL86.0</p>	<p>HL618 + HL86.0</p>	<p>HL620</p>
		
<p>HL65P</p>	<p>HL65F (HL65PE)</p>	<p>HL350</p>
		
<p>-</p>	<p>-</p>	<p>HL320</p>
		

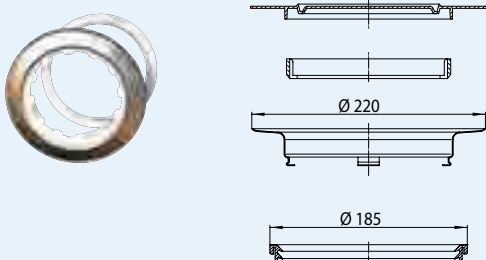
HL Гарнитурни за хидроизолацията - Продукти - Данни

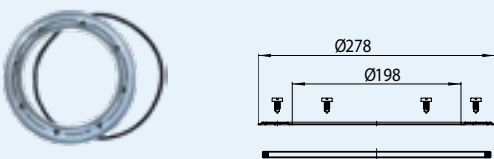
HL83.0, HL8300.0, HL84.0, HL86.0 Гарнитура за хидроизолацията без маншет

Данни						
Материал	Неръждаема стомана	HL83.0		 HL083.1E HL083.2E HL01023D		
Размер	HL83.0: Ø 196 x 114 мм HL8300.0: Ø 238 x 148 мм HL84.0: Ø 220 x 155 мм HL86.0: Ø 278 x 198 мм	HL8300.0		 HL086.1E HL08300.2E HL01092D		
Препоръчва се за	Монтиране на място (обекта) на хидроизолационната мембрана към фланеца на сифона	HL84.0		 HL062B.3E HL084.2E HL084.4E		
Подходяща е за	HL83.0: HL70, HL80, HL90(Pr), HL92, HL300, HL304, HL310N(Pr), HL510N(Pr) както и за Удължителен елемент HL85N HL8300.0: HL3100(Pr) и HL5100(Pr) както и за Удължителен елемент HL8500 HL84.0: HL72.1 и HL317 HL86.0: HL615 и HL616 както и за Удължителен елемент HL618	HL86.0		 HL086.1E HL086.2E HL086.0E		
		HL-Nr.	Тегло	EAN	Бр./опак.	EAN-пакет
		83.0	245 г	+718306	1	
		8300.0	303 г	+025497	1	
		84.0	395 г	+718405	1	
		86.0	340 г	+711864	1	

HL83.M, HL8300.M, HL84.M, HL86.M Гарнитура за хидроизолацията с каширан маншет

Данни

Материал	Неръждаема стомана/Каширан маншет
Размер	HL83.M: пръстен Ø 196 x 114 mm каширан маншет 400 x 500 mm HL8300.M: пръстен Ø 238 x 148 mm каширан маншет 500 x 500 mm HL84.M: пръстен Ø 220 x 155 mm каширан маншет 500 x 500 mm HL86.M: пръстен Ø 278 x 198 mm каширан маншет 500 x 500 mm
Препоръчва се за	Алтернативни или свързващи хидроизолации като например 2-компонентни епоксидни смоли или 2-компонентни флекс хидроизолации
Подходяща е за	HL83.M: HL70, HL80, HL90(Pr), HL92, HL300, HL304, HL310N(Pr), HL510N(Pr) както и за Удължителен елемент HL85N HL8300.M: HL3100(Pr) и HL5100(Pr) както и за Удължителен елемент HL8500 HL84.M: HL72.1 и HL317 HL86.M: HL615 и HL616 както и за Удължителен елемент HL618

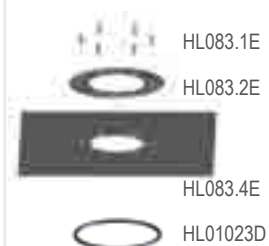
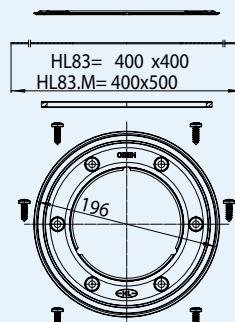
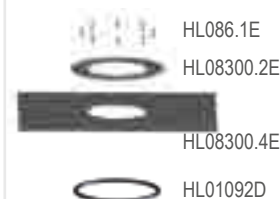
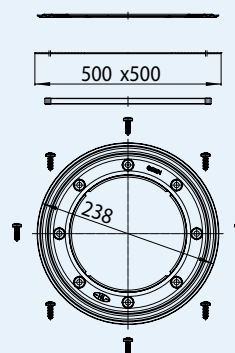
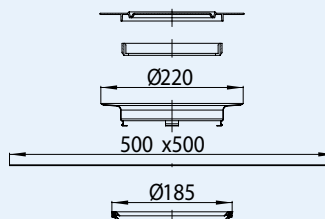
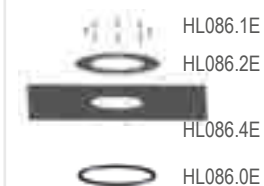
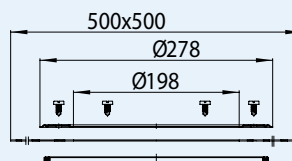
HL83.M

HL8300.M

HL84.M

HL86.M

HL-Nr.	Тегло	EAN	Бр./опак.	EAN-пакет
83.M	425 g	+030835	1	1
8300.M	425 g	+025473	1	1
84.M	730 g	+030842	1	1
86.M	590 g	+713868	1	1

HL83, HL8300, HL84, HL86 Гарнитура за хидроизолацията с маншет от EPDM

Данни

Материал	Неръждаема стомана/Маншет от EPDM
Размер	HL83: пръстен Ø 196 x 114 мм Маншет от EPDM 400 x 400 мм HL8300: пръстен Ø 238 x 148 мм Маншет от EPDM 500 x 500 мм HL84: пръстен Ø 220 x 155 мм Маншет от EPDM 500 x 500 мм HL86: пръстен Ø 278 x 198 мм Маншет от EPDM 500 x 500 мм
Препоръчва се за	EPDM хидроизолационни мембрани, както и битумни грундове и за залепване с битумни мембрани
Подходяща е за	HL83: HL70, HL80, HL90(Pr), HL92, HL300, HL304, HL310N(Pr), HL510N(Pr) както и за Удължителен елемент HL85N HL8300: HL3100(Pr) и HL5100(Pr) както и за Удължителен елемент HL8500 HL84: HL72.1 и HL317 HL86: HL615 и HL616 както и за Удължителен елемент HL618

HL83

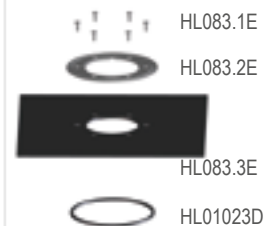
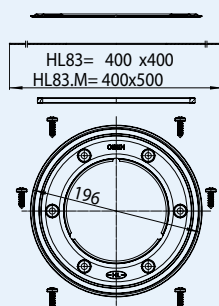

HL8300

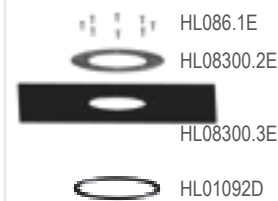
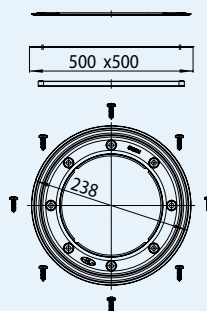
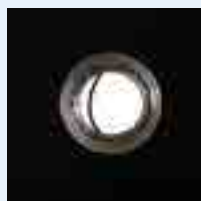

HL84

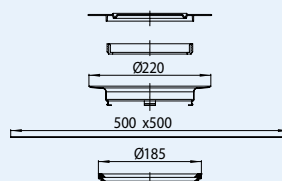
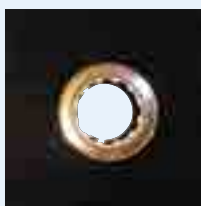

HL86

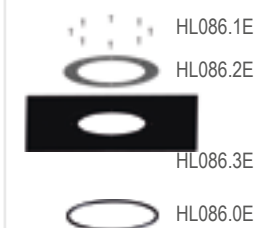
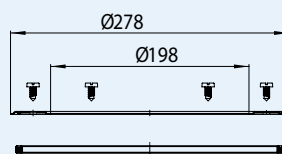
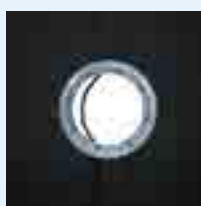

HL-Nr.	Тегло	EAN	Бр./опак.	EAN-пакет
83	425 r	+710836	1	
8300	601 r	+025466	1	
84	730 r	+710843	1	
86	590 r	+710867	1	

HL83.P, HL83.PP Гарнитура за хидроизолацията с PVC или PP яка

Данни						
Материал	HL83.P: PVC HL83.PP: PP	HL-Nr.	Тегло	EAN	Бр./опак.	EAN-пакет
Размер	HL83.P: яка Ø 290 мм HL83.PP: яка Ø 290 мм	83.P	425 г	+010837	1	
Препоръчва се за	HL83.P: PVC-хидроизолационни мембрани HL83.PP: FPO-хидроизолационни мембрани на PP-основа	83.PP	653 г	+028641	1	
Подходяща е за	HL70, HL80, HL90(Pr), HL92, HL300, HL304, HL310N(Pr), HL510N(Pr) както и за удължителен елемент HL85N					

HL8300.P, HL8300.PP Гарнитура за хидроизолацията с PVC или PP яка

Данни						
Материал	HL8300.P: PVC HL8300.PP: PP	HL-Nr.	Тегло	EAN	Бр./опак.	EAN-пакет
Размер	HL8300.P: яка Ø 350 мм HL8300.PP: яка Ø 350 мм	8300.P		+034741	1	
Препоръчва се за	HL8300.P: за PVC-хидроизолационни мембрани HL8300.PP: за FPO-хидроизолационни мембрани на PP-базис	8300.PP		+034758	1	
Подходяща е за	Серии HL3100 и HL5100 както и за удължителен елемент HL8500					

HL84.CU, HL84.E Гарнитура за хидроизолацията от медна ламарина или поцинкована ламарина

Данни						
Материал	HL84.CU: Медна ламарина HL84.E: Поцинкована ламарина	HL-Nr.	Тегло	EAN	Бр./опак.	EAN-пакет
Размер	HL84.CU: 500 x 500 мм HL84.E: 500 x 500 мм	84.CU	1835 г	+444847	1	
Препоръчва се за	HL84.CU: за покривна хидроизолация от медни ламарини HL84.E: за покривна хидроизолация от поцинковани ламарини	84.E	1830 г	+111848	1	
Подходяща е за	Воронка Серия HL62, HL63, HL64, HL65 и HL69					

HL Удължители - Продукти - Данни

HL320, HL340N, HL3400, HL350, HL620 Удължител за наставката

Данни					
Материал	PP	HL320			
Размер	HL320: Ø 89 мм, h: 35 мм HL340N: Ø 110 мм, h: 100 мм HL3400: Ø 146 мм, h: 200 мм HL350: Ø 145 мм, h: 155 мм HL620: Ø 195 мм, h: 125 мм	HL340N			 HL01067D
Препоръчва се за	Настройка по височина на наставките	HL3400			 HL01093D
Подходящ е за	HL320: HL92 HL340N: HL70, HL80, HL90(Pr), HL300, HL304, HL310N(Pr), HL510N(Pr) както и за Удължителен елемент HL85N HL3400: за серии HL3100, HL5100 HL350: HL72.1, HL317, HL62, HL63, HL64, HL65, HL69 HL620: HL615 и HL616	HL350			
		HL620			 HL01056D

HL-Nr.	Тегло	EAN	Бр./опак.	EAN-накет
340N	75 r	+003402	1	
3400	117 r	+025565	1	
350	240 r	+703500	1	
620	270 r	+014255	1	

HL85N, HL8500, HL350.1, HL350.0, HL618, HL65 Удължител с фланец за хидроизолацията

Данни					
Материал	PP	HL85N			
Размер	HL85N: Ø 110 x 220 мм, h: 227 мм HL8500: Ø 146 x 239 мм, h: 226 мм HL350.1 (HL350.0): Ø 145 x 300 мм, h: 220 мм HL618: Ø 195 x 315 мм, h: 155 мм HL65: Ø 125 x 354 мм, h: 345 мм	HL8500			 HL01067D HL03100.0E HL01093D
Препоръчва се за	За настройка на височината на удължителя до нивото на хидроизолацията	HL350.1 (HL350.0)			 HL062B.3E HL084.2E HL084.3E HL084.4E HL01059D HL01058D
Подходящ е за	HL85N: HL70, HL80, HL90(Pr), HL300, HL304, HL310N(Pr), HL510N(Pr) HL8500: HL3100(Pr) и HL5100(Pr) HL350.1 (HL350.0): HL72.1, HL317, HL62, HL63, HL64, HL65 и HL69 HL618: HL615, HL616 HL65: HL62, HL64	HL618			
		HL65			 HL062.4E HL170 HL062.3E HL01020D

HL-Nr.	Тегло	EAN	Бр./опак.	EAN-пакет
85N	395 г	+006120	1	
8500	320 г	+025572	1	
350.0	680 г	+032358	1	
350.1	1440 г	+703517	1	
618	500 г	+013159	1	
65	1440 г	+800650	1	

HL85NC, HL360 CeraDrain Удължител с полимербетонна яка

Данни

Материал	PP / полимербетон
Размер	HL85NC: Ø 110 мм, h: 118 мм, Фланец: 260 x 260 мм, Стоманена арматурна мрежа: 450 x 450 мм HL360: Ø 145 мм, h: 140 мм, Фланец: 307 x 307 мм, Стоманена арматурна мрежа: 503 x 503 мм
Препоръчва се за	Специално за алтернативни, респ. епоксидни хидроизолации или хидроизолационни лепила, с вградена полимербетонна яка и стоманена арматурна мрежа, винтове за настройка по височина, както и полимерна мрежа за преход над пукнатини в замазката. Препоръчва се за премостване на стари, нестабилни или тънки и слаби замазки.
Подходящ е за	Моделите сифони HL85NC: HL70, HL80, HL90(Pr), HL300, HL304, HL310N(Pr), HL510N(Pr) HL360: HL72.1, HL317

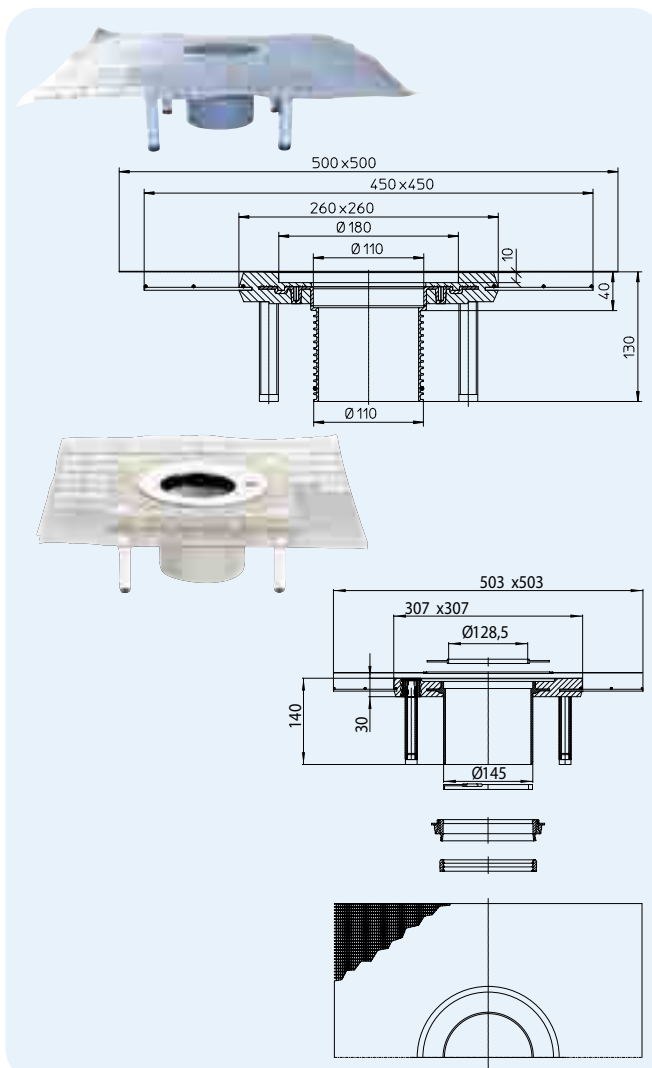

HL-Nr. 85NC 360	Тегло 3886 g 8000 g	EAN +006823 +703609	Бр./опак. 1 1	EAN-пакет
-----------------------	---------------------------	---------------------------	---------------------	-----------

HL370 Удължител „FlexDrain“

Данни

Материал	ABS
Размер	Ø 145 x 375 мм, h: 150 мм
Препоръчва се за	Специално за алтернативни, респ. епоксидни хидроизолации или хидроизолационни лепила, с омрежен и каширан пластмасов фланец, както и каширан маншет за преход над пукнатини в замазката, вкл. рамка и решетка
Подходяща е за	HL72.1 и HL317

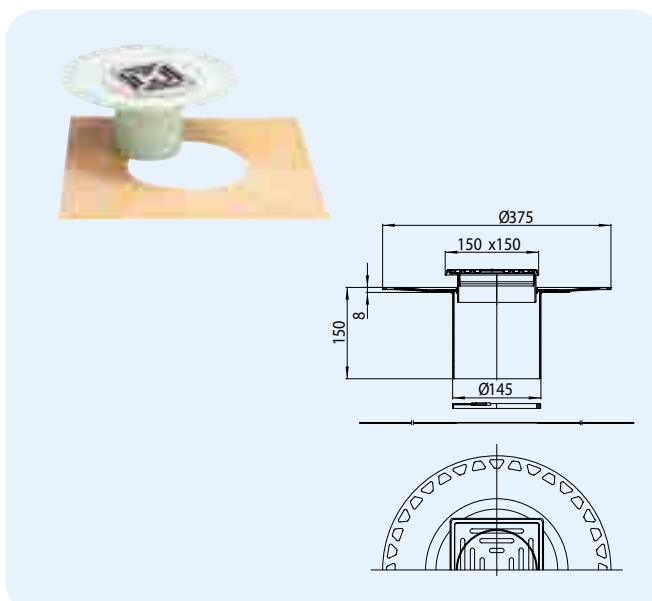

HL-Nr. 370	Тегло 930 g	EAN +010714	Бр./опак. 1	EAN-пакет
---------------	----------------	----------------	----------------	-----------

HL85NH, HL8500H, HL350.1H, HL618H, HL65H Удължителни със заводски заварен битумен маншет

Данни

Материал PP/Неръждаема стомана/Битум

 Размер **HL85NH:** Ø 110 мм, h: 227 мм,
 Битумен маншет: Ø 420 мм
HL8500H: Ø 146, h: 226 мм,
 Битумен маншет: 500 x 500 мм
HL350.1H: Ø 145, h: 225 мм,
 Битумен маншет: Ø 500 мм
HL618H: Ø 195 мм, h: 160 мм,
 Битумен маншет: 500 x 500 мм
HL65H: Ø 125 мм, h: 345 мм,
 Битумен маншет: Ø 500 мм

 Препоръчва се за битумни мембранни
 хидроизолации

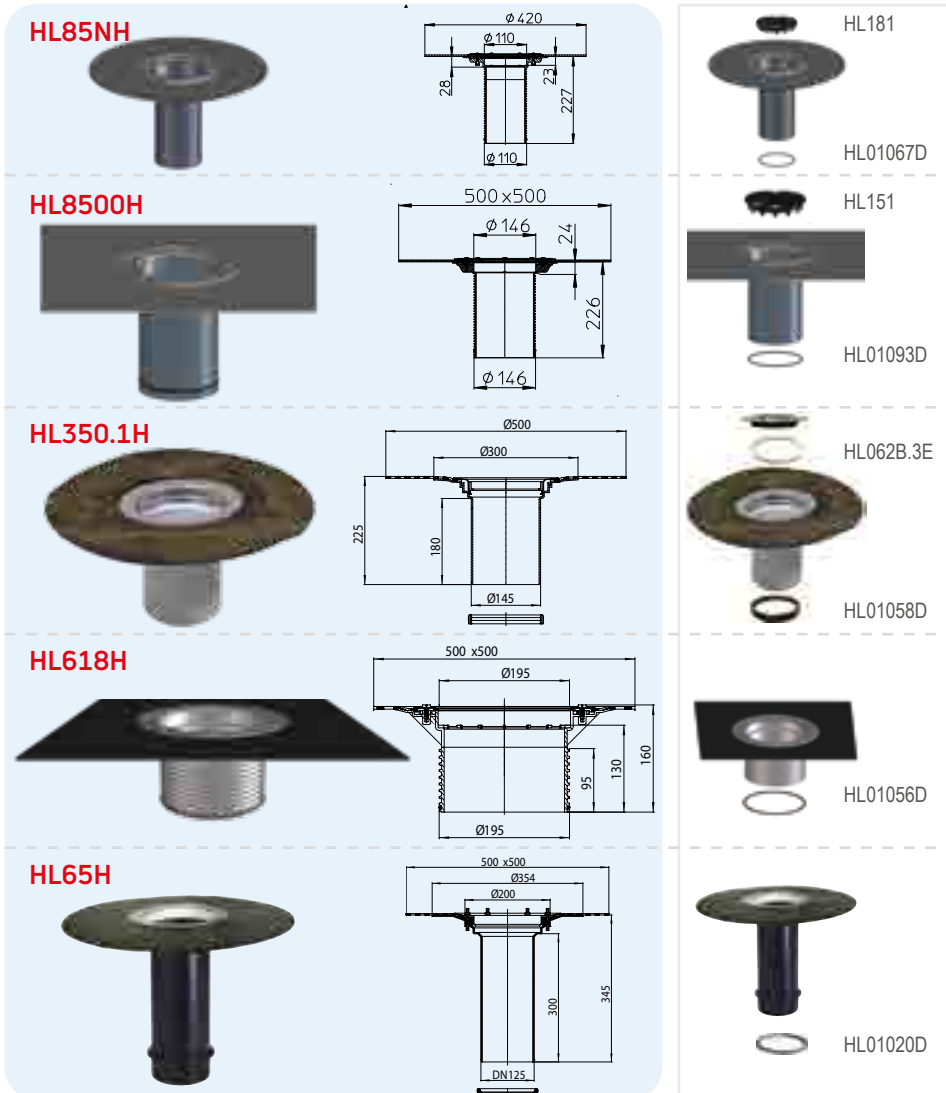
 Подходящ е за **HL85NH:** HL70, HL80, HL90(Pr),
 HL300, HL304, HL310N(Pr),
 HL510N(Pr)
HL350.1H: HL72.1, HL317, HL62,
 HL63, HL64, HL65, HL69
HL618H: HL615 и HL616
HL65H: HL62, HL64

HL-Nr.	Тегло	EAN	Бр./опак.	EAN-пакет
85NH	980 г	+009015	1	
350.1H	1550 г	+001842	1	
618H	1750 г	+013173	1	
65H	2140 г	+801657	1	

HL65P, HL65F, HL65PE Удължителни с фланец за хидроизолацията

Данни

 Материал **HL65P:** PVC
HL65F: PP
HL65PE: PE

 Размер Ø 125 мм, h: 345 мм,
 Фланец: Ø 355 мм

 Препоръчва се за **HL65P:** PVC покривна
 хидроизолационна мембрана
HL65F: FPO покривна
 хидроизолационна мембрана на
 PP-основа
HL65PE: FPO-
 хидроизолационни мембрани с
 химичен базис от PE

Подходящ е за воронки HL62 и HL64

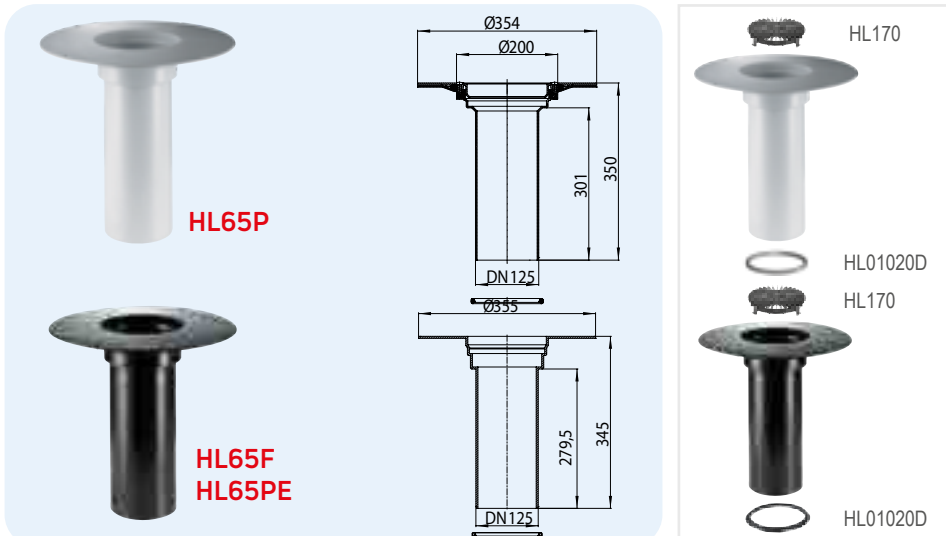

HL-Nr.	Тегло	EAN	Бр./опак.	EAN-пакет
65P	1370 г	+022588	1	
65F	830 г	+031900	1	
65PE	850 г	+035915	1	